

Service unit

»SYNTESI« series

PLUS

Art. No. 144970

Type No. 5611V10B16L101

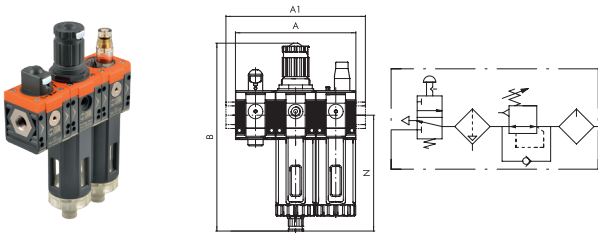

Exemplary illustration

Three-part maintenance units consisting of shut-off valve, filter regulator and lubricator of the »SYNTESI« series. For all information on the relevant properties, please refer to the data sheets of the individual components.

The shut-off valve is the manual version with 3.5 mm hole for padlocks.

Silencer not included in delivery!

Pressure gauge not included in delivery!

Technical data

Series	Syntesi
Size	1
Max. input pressure	15 bar
Temperature range	-10 to 50 °C
Control range	0 - 12 bar
Input	G 1/8
Output	G 1/8
Front and back port thread	G 1/8
Flow rate measurement 1	at $P_1 = 10$ bar, $P_2 = 6.3$ bar and pressure drop $\Delta_p = 0.5$ bar
Flow rate 1	250 NI/min
Flow rate measurement 2	at $P_1 = 10$ bar, $P_2 = 6.3$ bar and pressure drop $\Delta_p = 1$ bar
Flow rate 2	1050 NI/min
Filter rating	5 μ m
Condensate drain	RMSA semi-automatic
Output air purity class according to ISO 8573-1	3.7.-
Medium	Compressed air or other neutral gases
Housing	Technopolymer
Sealant	NBR
Diaphragms	NBR 60 Shore (hardness) with polyester fabric insert
Bowl	Technopolymer
Sight dome	Brass
Spring bonnet	Technopolymer
A	126.0 mm
A1	- mm
B	198.0 mm
N	122.2 mm

Commercial data

Customs tariff number	84811005
Country of origin	IT
eCl@ss 5.1.4	27292890
eCl@ss 9.0	27292890
UNSPSC_Code_v190501	27131604
UNSPSC_CodeDesc_v190501	Pneumatic lubricators

C1

V3V + FR + LUB SYNTESI®

For full details and list of components refer to the sections about shut-off valve, filter-regulator and lubricator.



UNITS

V3V + FR + LUB Syntesi®

TECHNICAL DATA	V3V + FR + LUB SY1			V3V + FR + LUB SY2				
	1/8"	1/4"	3/8"	3/8"	1/2"	3/4"	1"	
Threaded port	5 (yellow) - output air purity class ISO8573-1: 3.7.- 20 (white) - output air purity class ISO8573-1: 4.7.- 50 (blue) - output air purity class ISO8573-1: 5.7.-							
Degree of filtration	µm							
Max. inlet pressure	bar		15	13				
	MPa		1.5	1.3				
	psi		217	188				
Flow rate at 6.3 bar (0.63 MPa; 91 psi) ΔP 0.5 bar (0.05 MPa; 7 psi)	NL/min		250	1200				
(P In=10 bar)	scfm		9	42.5				
Flow rate at 6.3 bar (0.63 MPa; 91 psi) ΔP 1 bar (0.1 MPa; 14 psi)	NL/min		1050	4000				
(P In=10 bar)	scfm		37	141.5				
Relief valve flow rate at 6.3 bar (0.63 MPa; 91 psi)	NL/min		70	100				
	scfm		2.5	3.5				
Min/max temperature at 10 bar; 1 MPa; 145 psi	°C			From -10 to +50				
Full outflow with zero inlet pressure	Included			Included				
Drain flow rate at 6.3 bar (0.63 MPa; 91 psi)	NL/min		500	2000				
	scfm		18	71				
Padlockable knob	Included with both V3V and regulator							
Upstream pressure compensation	Included, via balanced valve							
Weight	g	598	593	584	1479	1452	1448	1436
Fluid	Compressed air or other inert gases							
Mounting position	Vertical			Vertical				
Additional air take-off, for pressure gauges or fittings	1/8", front and rear			1/4", front and rear				
Additional air take-off flow rate at 6.3 bar	NL/min		500 (V3V) - 500 (FR) - 450 (LUB)	1500 (V3V) - 1400 (FR) - 800 (LUB)				
(0.63 MPa; 91 psi) ΔP 1 bar (0.1 MPa; 14 psi)	scfm		18 (V3V) - 18 (FR) - 16 (LUB)	53 (V3V) - 49.5 (FR) - 28 (LUB)				
Filter bowl capacity	cm ³		30	70				
Quantity of filled oil	cm ³		60	130				
Condensate drain	RMSA: drain with manual condensate discharge and automatic discharge at zero pressure RA: automatic drain with condensate discharge, independent of pressure and flow rate. Version conveys the draining by inserting the pipe having internal diameter 6 mm in the lower port. SAC: automatic drain with condensate discharge. Operates by pressure drop - requires variable air take-offs. Note: the maximum input pressure for the RA version must not exceed 10 bar							
Recommended oils	ISO and UNI FD22 (Energol HPL; Spinesso; Mobil DTE; Tellus oil)							
Wall fixing screws	No. 2 M4 screws			No. 2 M5 screws				

C1.48

OVERALL DIMENSIONS

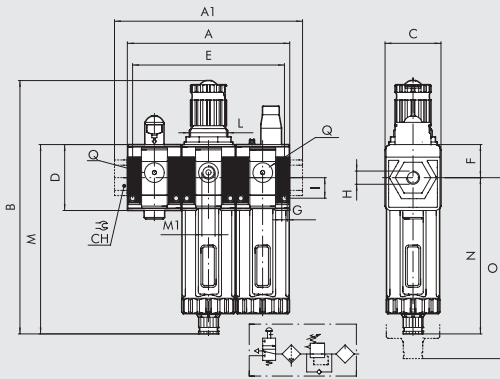

	SIZE 1			SIZE 2			
	1/8"	1/4"	3/8"	3/8"	1/2"	3/4"	1"
H (threaded port)	1/8"	1/4"	3/8"	3/8"	1/2"	3/4"	1"
A	126					181.5	
A1	-	-	128	-	-	217	217
B	RMSA 198			246			
	RA/SAC 202			250			
C	44			61			
CH	-			-	-	32	36
D	51.5			70.5			
E	117.1			168.5			
F	25.8			38.2			
G	Hole for M4 screws			Hole for M5 screws			
I	16			22.5			
L	M30x1.5			M38x2			
M	RMSA 148			178			
	RA/SAC 152			182			
M1 (pressure gauge port)	1/8"			1/4"			
N	RMSA 122.2			139.8			
	RA/SAC 126.2			143.8			
O	RMSA 202			245			
	RA/SAC 206			249			
Q (no. 2 additional air takes-off)	1/8"			1/4"			

KEY TO CODES

56	1	1	V	10	B	24	L	10	1
SYNTESI	SIZE	THREADED INPUT CONNECTION	ELEMENT	TYPE	ELEMENT	DEGREE OF FILTRATION, TYPE OF CONDENSATE DRAIN AND SETTING RANGE	ELEMENT	OIL FILLING	THREADED OUTPUT CONNECTION
56 Syntesi 5X Syntesi anti-corrosion	1 Size 1 2 Size 2	1 1/8" port 2 1/4" port 3 3/8" port 4 1/2" port 5 3/4" port 6 1" port	V V3V	10 Manual with Ø3.5 hole for padlocks 11 Manual with Ø7 hole for padlock	B Filter-regulator	<ul style="list-style-type: none"> ● 10 5 µm, RMSA, 0 to 2 bar ● 20 20 µm, RMSA, 0 to 2 bar ● 30 50 µm, RMSA, 0 to 2 bar ● 40 5 µm, RA, 0 to 2 bar ● 50 20 µm, RA, 0 to 2 bar ● 60 50 µm, RA, 0 to 2 bar ● 11 5 µm, SAC, 0 to 2 bar ● 21 20 µm, SAC, 0 to 2 bar ● 31 50 µm, SAC, 0 to 2 bar ● 12 5 µm, RMSA, 0 to 4 bar ● 22 20 µm, RMSA, 0 to 4 bar ● 32 50 µm, RMSA, 0 to 4 bar ● 42 5 µm, RA, 0 to 4 bar ● 52 20 µm, RA, 0 to 4 bar ● 62 50 µm, RA, 0 to 4 bar ● 13 5 µm, SAC, 0 to 4 bar ● 23 20 µm, SAC, 0 to 4 bar ● 33 50 µm, SAC, 0 to 4 bar 14 5 µm, RMSA, 0 to 8 bar 24 20 µm, RMSA, 0 to 8 bar 34 50 µm, RMSA, 0 to 8 bar 44 5 µm, RA, 0 to 8 bar 54 20 µm, RA, 0 to 8 bar 64 50 µm, RA, 0 to 8 bar 15 5 µm, SAC, 0 to 8 bar 25 20 µm, SAC, 0 to 8 bar 35 50 µm, SAC, 0 to 8 bar 16 5 µm, RMSA, 0 to 12 bar 26 20 µm, RMSA, 0 to 12 bar 36 50 µm, RMSA, 0 to 12 bar 46 5 µm, RA, 0 to 12 bar 56 20 µm, RA, 0 to 12 bar 66 50 µm, RA, 0 to 12 bar 17 5 µm, SAC, 0 to 12 bar 27 20 µm, SAC, 0 to 12 bar 37 50 µm, SAC, 0 to 12 bar 	L Lubricator	10 Manual filling from the top	1 1/8" port 2 1/4" port 3 3/8" port 4 1/2" port 5 3/4" port 6 1" port

● Not available in the anti-corrosion version.
 + Anti-corrosion version available only in size 1.
 RMSA: drain with manual condensate discharge and automatic discharge at zero pressure.
 RA: automatic drain with condensate discharge, independent of pressure and flow rate. Version conveys the draining by inserting the pipe having internal diameter 6 mm in the lower port.
 SAC: automatic drain with condensate discharge. Operates by pressure drop – requires variable air take-offs.

UNITS

V3V + FR + LUB Syntesi®

PURCHASE ORDER CODES HAVING A MORE FREQUENT USE

N.B. Besides the below mentioned codes, you can order elements composed at your will according to the key to codes.

Code	Description	Code	Description	NOTE
V3V + FR + LUB Syntesi[®] SY1		V3V + FR + LUB Syntesi[®] SY2		Anti-corrosion version
5611V10B24L101	V3V+FR+LUB SY1 1/8 20 08 RMSA	5623V10B24L103	V3V+FR+LUB SY2 3/8 20 08 RMSA	5X -----
5611V10B54L101	V3V+FR+LUB SY1 1/8 20 08 RA	5623V10B54L103	V3V+FR+LUB SY2 3/8 20 08 RA	Example
5612V10B24L102	V3V+FR+LUB SY1 1/4 20 08 RMSA	5624V10B24L104	V3V+FR+LUB SY2 1/2 20 08 RMSA	5X11V10B54L101 V3V+FR+LUB SY1 1/8 20 08 RA
5612V10B54L102	V3V+FR+LUB SY1 1/4 20 08 RA	5624V10B54L104	V3V+FR+LUB SY2 1/2 20 08 RA	anti-corrosion
5613V10B24L103	V3V+FR+LUB SY1 3/8 20 08 RMSA	5625V10B24L105	V3V+FR+LUB SY2 3/4 20 08 RMSA	
5613V10B54L103	V3V+FR+LUB SY1 3/8 20 08 RA	5625V10B54L105	V3V+FR+LUB SY2 3/4 20 08 RA	
		5626V10B24L106	V3V+FR+LUB SY2 1 20 08 RMSA	
		5626V10B54L106	V3V+FR+LUB SY2 1 20 08 RA	

NOTES

UNITS

V3V + FR + LUB Syntesi[®]

GENERAL TECHNICAL DATA SYNTESI®

Syntesi® is an important milestone achieved by Metal Work, the result of thirty years' experience producing air-treatment units. It has been studied in minute detail to obtain the best possible performance in a reduced space and with limited weight. The capacity is much higher than that of other units of the same size.

This modular unit features a very simple yet effective system that requires no brackets, stay bolts or yoke for assembling the elements.

The basic version of Syntesi® incorporates numerous functions that are not provided or are only optional with traditional units. Examples are padlockable knobs, additional pneumatic ports on the front and back, flow options from left to right or vice versa, regulators with compensation system - which are accurate even when the upstream pressure changes, with rapid downstream pressure relief - full indelible marking, automatic condensate drain even in size 1, and 360° visual inspection of oil and condensate levels. The basic materials, technopolymer and nickel-plated brass have excellent corrosion resistance. An anti-corrosion version is available with stainless steel components (screws, plates) or Geomet®-treated ones (regulator springs).



UNITS

GENERAL TECHNICAL DATA Syntesi®

TECHNICAL DATA	SIZE 1			SIZE 2			
	1/8"	1/4"	3/8"	3/8"	1/2"	3/4"	1"
Threaded port							
Max. input pressure	bar	15			13		
	MPa	1.5			1.3		
	psi	217			188		
Flow rate	See catalogue of the various elements						
Min/max temperature at 10 bar; 1 MPa; 145 psi	°C from -10 to +50			°C from -10 to +50			
Padlockable knob	The knobs of the regulators, filter regulators and standard sectioning valves can all be padlocked						
Fluid	Compressed air or other inert gases						
Mounting position	See catalogue of the various elements						
Direction of flow	Flow options right to left or vice versa						
Additional air take-off, for pressure gauges or fittings	1/8", front and rear, on all modules			1/4", front and rear, on all modules			
Wall fixing screws	No. 2 M4 screws			No. 2 M5 screws			
Certification for potentially explosive atmosphere according to ATEX 2014/34/EU rule	 II 3G Ex h IIC T5 Gc -10°C < Ta < 50°C II 3D Ex h IIIC T100 °C Dc						

ANTI-CORROSION VERSION

- Differences compared to the standard version:
- stainless steel screws
 - stainless steel plate for R, FR, V3V knobs
 - Geomet®-treated regulator spring and filter-regulator

FIXING TO FRONT PORTS



Do not use a spanner for fixing taper threaded elements to the front ports. Mount by hand and apply a liquid sealant (not teflon®).

ROTARY BUSHINGS



3/4" and 1" bushings in Size 2 rotate freely to facilitate assembly operations.

LASER MARKING

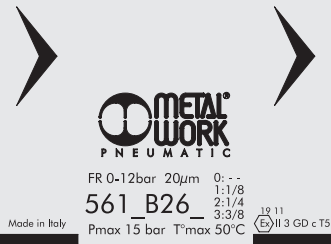

The following is marked indelibly on the body:

- Metal Work trademark
- Code
- Maximum pressure and temperature
- Degree of filtration or pressure range, where relevant
- Week and year of manufacture
- ATEX category
- Made in Italy

MOUNTING OPTIONS

On the wall, using two screws

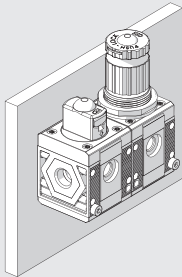

On a panel

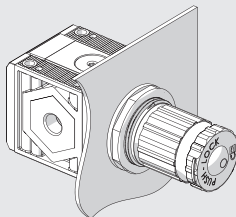

Using knob bracket

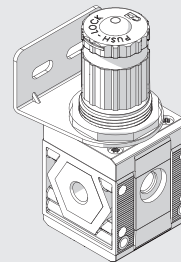

Using a bracket

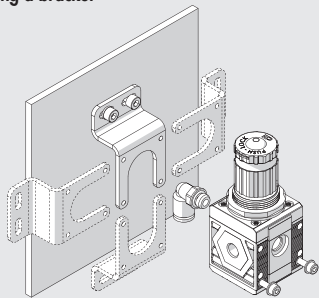

The bracket can be secured in any position, and the fittings can be mounted on the pressure gauge air intake at the back of the unit.

On a DIN EN50022 bar with the opposite adaptor

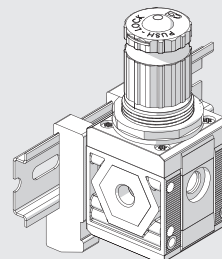

UNITS

GENERAL TECHNICAL DATA Synthesi®

MODULARITY AND FLEXIBILITY

UNITS

GENERAL TECHNICAL DATA Syntesi®



The various elements of Syntesi® A can be connected to the air feed and delivery circuit using pneumatic nickel brass or passivated aluminium ports® and can be fixed together using nipples®.

The nipples and ports are easy to remove by unscrewing the two front screws®. This solution has numerous advantages:

- Reduced overall dimensions.
- Free composition of multiple elements, without the need for brackets, stay bolts or yoke.
- The threads for the fittings are metallic, allowing high tightening torques, also for tapered threads.
- Maximum flexibility: a unit can be transformed at any time by adding an element or replacing a port with another one, e.g. 1/4" instead of 1/8".
- The air intake port can be the same or different from the outlet port, as desired.

Standard Syntesi® ports are: 1/8", 1/4", 3/8" for size 1; 3/8", 1/2", 3/4", 1" for size 2.

It may be necessary to use a vice to insert the bushes into size 2.

The nipples have different functions:

- Nipple® joins two elements of the same size together.
- Size adaptor® can be used to connect an element in the Syntesi® 2 series with one in the Syntesi® 1 series.
- The 90° adaptor® can be used to connect two 90° angled elements. For example, it can help directing the regulator knob or the control knob of a sectioning valve towards the user.
- The two-way air intake® is a simple and cost-effective system which, besides connecting two elements together, has 2 opposing threaded air intakes.
- The adaptor for Regtronic® can be used to fix the Regtronic 1/4" proportional valve to a Syntesi® size 1 element.

Additional ports®. On the front and back of ALL Syntesi® elements there is a port (1/8" for size 1, 1/4" for size 2) that can be used for pressure gauges®, pressure switches® or, given the high flow rate, as additional air take-off®. These ports are downstream of the element, so, for example, a regulator port can supply air at a set pressure or a filter port can supply filtered air (not valid for activated carbon filter and depurator).

Wall fixing. Only two through screws® are needed. No bulky brackets or additional flanges are required. The bracket® can be used to separate the unit from the fixing wall, e.g. to mount a fitting to the rear port.

Fixing on a DIN EN50022 bar. Can be done using the bracket kit®.

Regulator fixing bracket®. Regulators and filter-regulators can also be fixed using a steel bracket® that embraces the bell.

Padlockable knob®. The knobs of regulators, filter-regulator and sectioning valves can all be padlocked. The steel plate is included in the supply. You can insert up to two 3 mm diameter padlocks® on size 1 and three padlocks on size 2. As an alternative, the sectioning valve can have a steel plate suitable for a single 6 mm diameter padlock.

Safety valve®. The unit can incorporate a series 70 SAFE AIR® safety valve.

Flowmeter series FLUX 1-2®. The unit can incorporate a series FLUX 1 or FLUX 2 flow meter.

C1

SYNTESI® KEY TO CODES

KEY TO CODES SINGLE ELEMENT

56	1	1	F	10	1
SYNTESI	SIZE	THREADED INPUT CONNECTION	ELEMENT	TYPE	THREADED OUTPUT CONNECTION
56 Syntesi 5X Syntesi anti-corrosion	1 Size 1	0 Without bushing 1 1/8" port 2 1/4" port 3 3/8" port	F Filter D Depurator C Active carbon filter R Pressure regulator B Filter-regulator L Lubricator ● V Shut off valve ▲ A Progressive starter ▲ S Pressure switches P Air take-off	Varies from element to element	0 Without bushing 1 1/8" port 2 1/4" port 3 3/8" port
	2 Size 2	0 Without bushing 3 3/8" port 4 1/2" port 5 3/4" port 6 1" port			0 Without bushing 3 3/8" port 4 1/2" port 5 3/4" port 6 1" port

- The anti-corrosion version of this element is only available with manual actuation.
- ▲ Not available in the anti-corrosion version.

KEY TO CODES UNIT COMPOSED OF TWO OR THREE ELEMENTS

56	1	1	V	10	B	24	L	10	1
SYNTESI	SIZE	THREADED INPUT CONNECTION	ELEMENT 1	TYPE	ELEMENT 2	TYPE	ELEMENT 3	TYPE	THREADED OUTPUT CONNECTION
56 Syntesi 5X Syntesi anti-corrosion	1 Size 1	1 1/8" port 2 1/4" port 3 3/8" port	F Filter D Depurator C Active carbon filter R Pressure regulator B Filter-regulator L Lubricator ● V Shut off valve ▲ A Progressive starter ▲ S Pressure switches P Air Take-off	Varies from element to element	F Filter D Depurator C Active carbon filter R Pressure regulator B Filter-regulator L Lubricator ● V Shut off valve ▲ A Progressive starter ▲ S Pressure switches P Air Take-off	Varies from element to element	F Filter D Depurator C Active carbon filter R Pressure regulator B Filter-regulator L Lubricator ● V Shut off valve ▲ A Progressive starter ▲ S Pressure switches P Air Take-off	Varies from element to element	1 1/8" port 2 1/4" port 3 3/8" port 3 3/8" port 4 1/2" port 5 3/4" port 6 1" port
	2 Size 2	3 3/8" port 4 1/2" port 5 3/4" port 6 1" port							

- The anti-corrosion version of this element is only available with manual actuation.
- ▲ Not available in the anti-corrosion version.

UNITS

Syntesi® KEY TO CODES

C1.8

Accessories

	Art. No.	Type No.
Bowl, size 1, RA fully automated	145612	9210101
Bowl, size 1, SAC fully automated	145613	9210102
Filter element, size 1, 20 µm	145620	9210151
Filter element, size 1, 50 µm	145621	9210152
Valve poppet for filter regulator, size 1, 20 µm	145652	9210212
Valve poppet for filter regulator, size 1, 50 µm	145653	9210213
Mounting bracket, size 1, standard and anti-corr.	145658	9200716X
Adapter for DIN rail, size 1 and size 2	145660	9200718X
Pressure gauge, G1/8 rear centric, 0-12 bar, Ø40mm	145470	9700101
Pressure gauge, G1/8 rear centric, 0-12 bar, Ø50mm	145472	9800101
Pressure gauge, G1/8 rear cent., 0-12 bar, 40x40mm	145476	9700110
Connecting nipple kit, size 1	144695	9210000
Connecting element 90°, size 1	145502	9210009
Size adapter, size 1 - size 2, incl. 4 screws	145504	9210006
Assembly key for bowl size 1, »bit«	145505	9170601
Fastening screw, size 1	145507	9210030
Padlock	145509	9062401

Spareparts

	Art. No.	Type No.
Bowl, size 1, RMSA semi-automated	145611	9210100
Bowl for lubricator, size 1, PA12	145617	9210110
Filter element, size 1, 5 µm	145619	9210150
Lubricator dome (drip cap), s1, w. oil filling cap	145629	9210180
Oil filling cap, size 1	145631	9210181
Spring, size 1, 0 - 12 bar	145636	9210193
Regulator cap (bell), size 1, 0 - 12 bar	145644	9210203
Valve poppet for filter regulator, size 1, 5 µm	145651	9210211
Threaded port bushing, size 1, G 1/8	144688	9210001