

Mid section

ZRL1 series

Art. No. 129652

Type No. MB.ZRL1.63



Exemplary illustration

Technical data

For cylinders	ZRL1C, ZRL1F, ZRL1S
Suitable for piston Ø	63 mm
Version	2 pieces with 4 screws and 4 slot nuts
Material	Aluminium

Commercial data

Customs tariff number	84129080
Country of origin	DE
eCl@ss 5.1.4	27299202
eCl@ss 9.0	27299202
UNSPSC_Code_v190501	27131708
UNSPSC_CodeDesc_v190501	Mounting bases for pneumatic cylinder

Mid section support for ZRL1C, ZRL1F, ZRL1S - 2 pieces
 Mid section mounting for ZRL1C, ZRL1F, ZRL1S - 2 pieces with 4 screws and 4 slot nuts

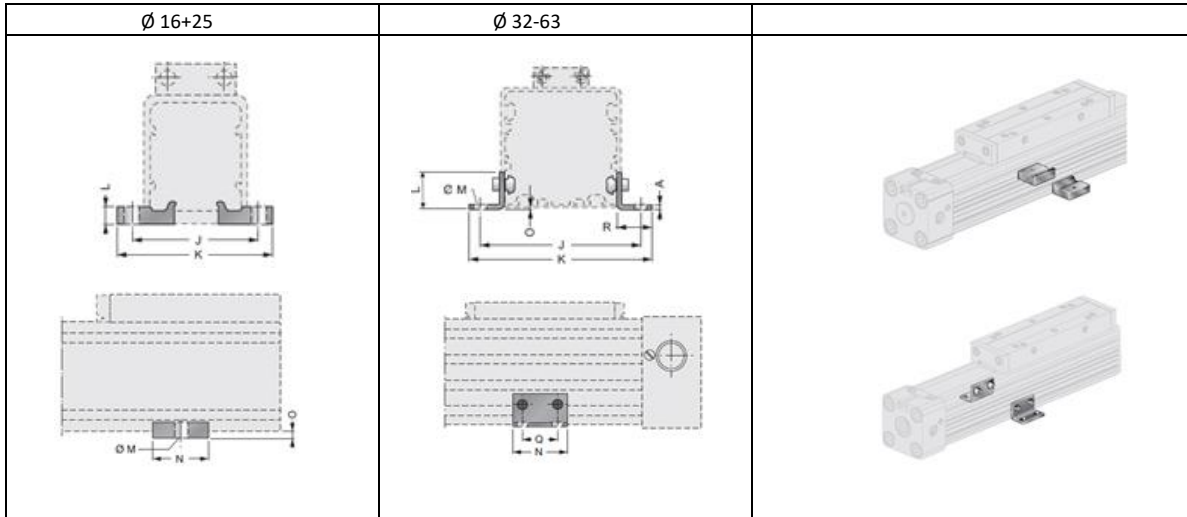

Art. No.	Type No.	Ø	J	K	L	M	N	O	Q	R
129647	ZS.ZRL1.16	16	41.5	53.5	5	5.5	20	3.0	-	-
129648	ZS.ZRL1.25	25	48.5	60.0	6	5.5	20	4.0	-	-
129649	MB.ZRL1.32	32	82.0	91.0	30	4.5	45	6.0	30	20
129650	MB.ZRL1.40	40	90.0	99.0	25	4.5	45	8.5	30	20
129651	MB.ZRL1.50	50	123.0	148.0	35	6.5	45	1.0	30	35
129652	MB.ZRL1.63	63	147.0	172.0	35	6.5	45	3.5	30	35



ZS.ZRL1.25



MB.ZRL1.40