

Zwischenstütze

Serie ZRL1

Artikel Nr. 129647

Typen Nr. ZS.ZRL1.16

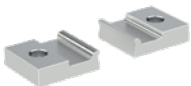

Beispielhafte Darstellung

Technische Informationen

für Zylinder	ZRL1C, ZRL1F, ZRL1S
passend für Kolben-Ø	16 mm
Ausführung	2 Stück
Material	Aluminium

Kaufmännische Daten

Zolltarifnummer	84129080
Ursprungsland	DE
eCl@ss 5.1.4	27299202
eCl@ss 9.0	27299202
UNSPSC_Code_v190501	27131708
UNSPSC_CodeDesc_v190501	Mounting bases for pneumatic cylinder

Zwischenstütze für ZRL1C, ZRL1F, ZRL1S - 2 Stück
 Mittelbefestigung für ZRL1C, ZRL1F, ZRL1S - 2 Stück mit 4 Schrauben und 4 Nutensteinen

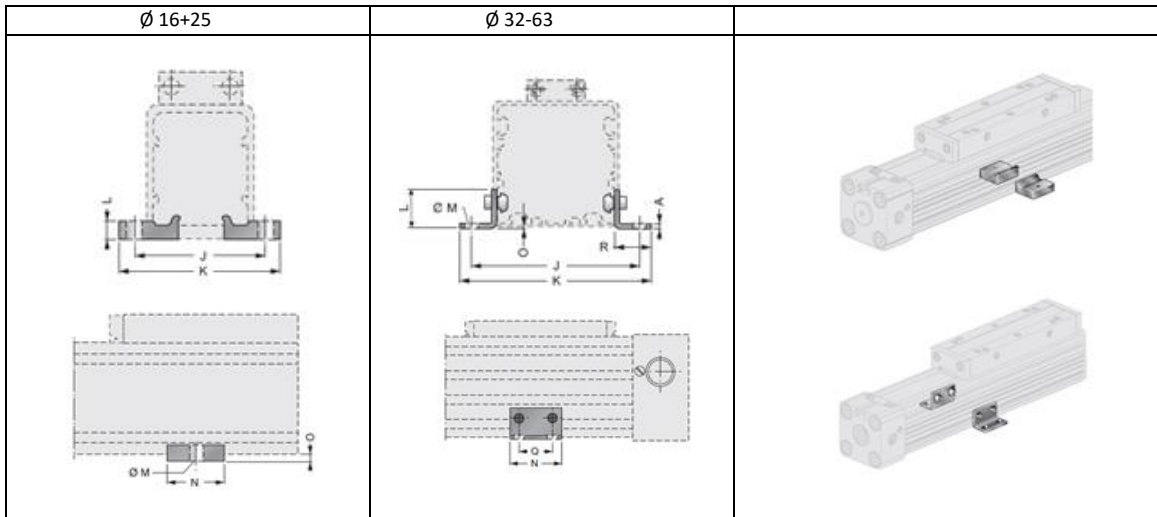

Artikel Nr.	Typen Nr.	Ø	J	K	L	M	N	O	Q	R
129647	ZS.ZRL1.16	16	41,5	53,5	5	5,5	20	3,0	-	-
129648	ZS.ZRL1.25	25	48,5	60,0	6	5,5	20	4,0	-	-
129649	MB.ZRL1.32	32	82,0	91,0	30	4,5	45	6,0	30	20
129650	MB.ZRL1.40	40	90,0	99,0	25	4,5	45	8,5	30	20
129651	MB.ZRL1.50	50	123,0	148,0	35	6,5	45	1,0	30	35
129652	MB.ZRL1.63	63	147,0	172,0	35	6,5	45	3,5	30	35



ZS.ZRL1.25



MB.ZRL1.40