

Double threaded nipple, reducing

Stainless steel 1.4408

STAINLESS STEEL

Art. No. 119197

Type No. DGNG1418ES4408RED



Exemplary illustration

Technical data

Max. working pressure	20 bar
Male thread 1	G 1/4
Male thread 2	G 1/8
L1	22.5 mm
a/f	15 mm
Thread form	parallel male thread
Standard thread	DIN EN ISO 228-1
Version	Hexagonal

From thread size of 1 inch, we recommend using an adjustable open-end wrench.

To ensure a proper sealing of the cylindrical threads (G) and tapered threads (R/Rp) we recommend using a suitable sealant (e.g. hemp, sealing tape or suitable industrial adhesive).

Commercial data

Customs tariff number	73072910
Country of origin	CN
eCl@ss 5.1.4	22360606
eCl@ss 9.0	22560206
UNSPSC_Code_v190501	40173303
UNSPSC_CodeDesc_v190501	Stainless steel pipe nipple

Material informations

REACH SVHC1 substance name	no
CAS no. SVHC 1	no CAS No.
RoHS materials notice	RoHS compliant
REACH Info	no SVHC substance included

Dimensions

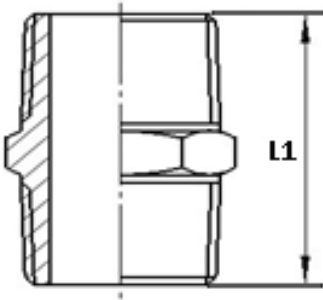

Male thread 1	Male thread 2	L1 mm	a/f mm
G 1/4	G 1/8	22.5	15

From thread size of 1 inch, we recommend using an adjustable open-end wrench.

To ensure a proper sealing of the cylindrical threads (G) and tapered threads (R/Rp) we recommend using a suitable sealant (e.g. hemp, sealing tape or suitable industrial adhesive).