

Removable double threaded nipple

Stainless steel 1.4408

STAINLESS STEEL

Art. No. 117909

Type No. LDGNR1ES4408KDII



Exemplary illustration

Technical data

Max. working pressure	20 bar
Thread	Rp 1
L1	50.3 mm
a/f 1	54 mm
a/f 2	39 mm
Thread form	parallel female thread
Standard thread	DIN EN ISO 7-1
Version	taper seat

From thread size of 1 inch, we recommend using an adjustable open-end wrench.

To ensure a proper sealing of the cylindrical threads (G) and tapered threads (R/Rp) we recommend using a suitable sealant (e.g. hemp, sealing tape or suitable industrial adhesive).

Commercial data

Customs tariff number	73072910
Country of origin	CN
eCl@ss 5.1.4	22360606
eCl@ss 9.0	22560206
UNSPSC_Code_v190501	40173303
UNSPSC_CodeDesc_v190501	Stainless steel pipe nipple

Material informations

REACH SVHC1 substance name	no
CAS no. SVHC 1	no CAS No.
RoHS materials notice	RoHS compliant
REACH Info	no SVHC substance included

Dimensions

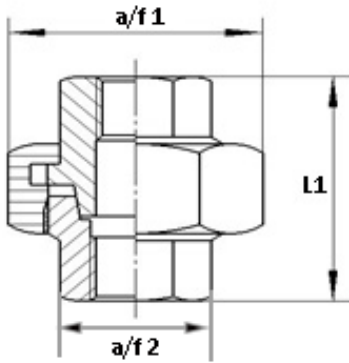

Thread	L1 mm	a/f 1 mm	a/f 2 mm
Rp 1	50.3	54	39

From thread size of 1 inch, we recommend using an adjustable open-end wrench.

To ensure a proper sealing of the cylindrical threads (G) and tapered threads (R/Rp) we recommend using a suitable sealant (e.g. hemp, sealing tape or suitable industrial adhesive).